

64ANC16

Revision 2

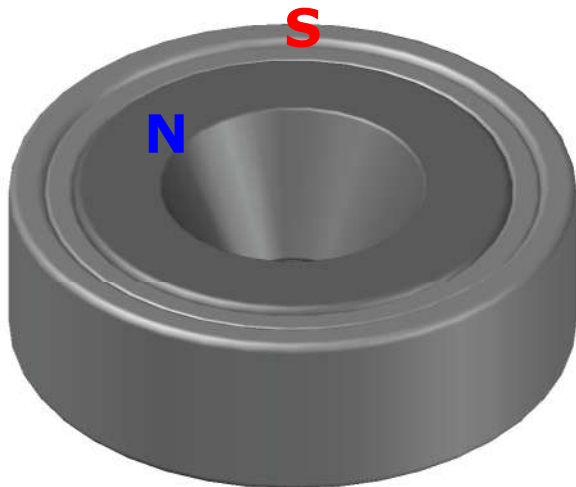
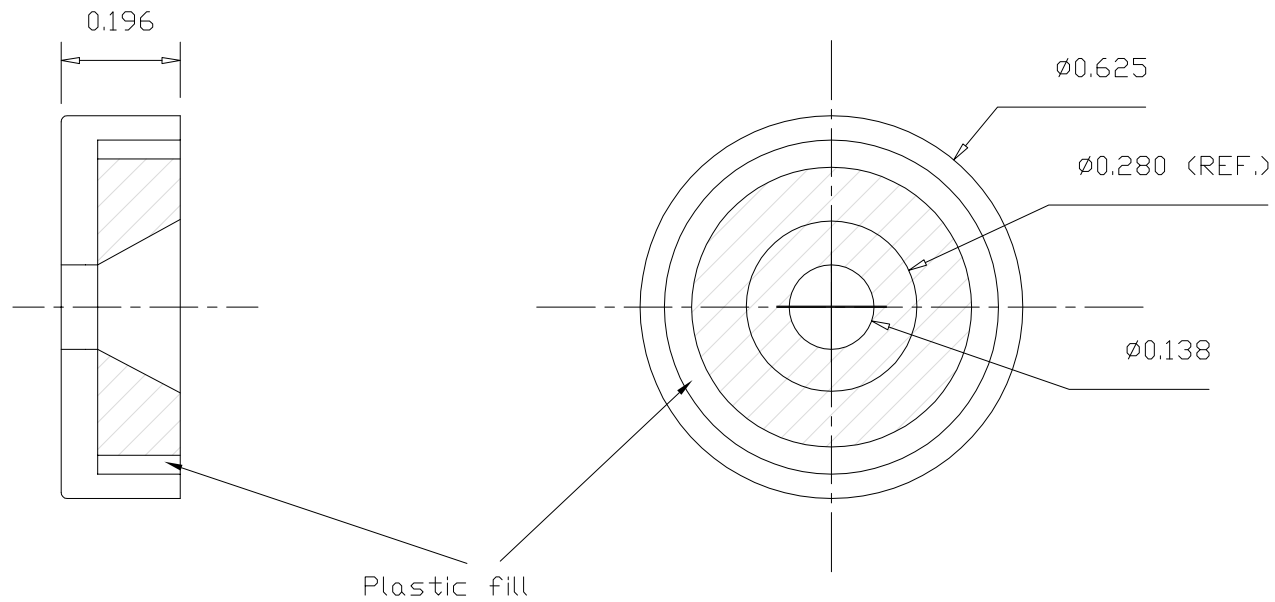

Specifications:

- 1) Neo magnet
- 2) Nickel plated steel cup
- 3) Magnet and cup are glued
- 4) Pull pounds: 9 lbs typical. (Tested on a clean, ground steel plate 0.375" thick)
- 5) Working temperature range: $-40^{\circ}\text{C} \sim 80^{\circ}\text{C}$
- 6) All dimensions are inches